



THIN TWIN® AUTOMATIC GAS AND ELECTRIC WASHER/DRYER

Use & Care Guide

For questions about features, operation/performance,
parts, accessories or service call: **1-800-253-1301**

or visit our website at
www.whirlpool.com/canada

Table of Contents..... 2

TABLE OF CONTENTS

| | |
|--|-----------|
| WASHER/DRYER SAFETY | 3 |
| PARTS AND FEATURES | 5 |
| CHECKING YOUR VENT | 6 |
| WASHER USE | 7 |
| Understanding Washer Cycles | 7 |
| Loading..... | 7 |
| Normal Washer Sounds | 7 |
| Starting Your Washer..... | 8 |
| Selecting a Cycle and Time | 9 |
| Rinse and Spin | 9 |
| Drain and Spin..... | 9 |
| Adding Liquid Chlorine Bleach | 9 |
| Adding Liquid Fabric Softener | 9 |
| DRYER USE | 10 |
| Starting Your Dryer..... | 10 |
| Stopping and Restarting | 10 |
| Loading..... | 10 |
| Drying, Cycle and Temperature Tips | 11 |
| Cycle Descriptions | 11 |
| End of Cycle Signal | 11 |
| WASHER/DRYER CARE | 12 |
| Cleaning Your Washer | 12 |
| Water Inlet Hoses..... | 12 |
| Cleaning the Dryer Interior | 12 |
| Cleaning the Lint Screen..... | 12 |
| Removing Accumulated Lint..... | 13 |
| Vacation, Storage, and Moving Care..... | 13 |
| TROUBLESHOOTING WASHER | 14 |
| TROUBLESHOOTING DRYER | 16 |
| ASSISTANCE OR SERVICE | 17 |

WASHER/DRYER SAFETY

Your safety and the safety of others are very important.

We have provided many important safety messages in this manual and on your appliance. Always read and obey all safety messages.



This is the safety alert symbol.

This symbol alerts you to potential hazards that can kill or hurt you and others.

All safety messages will follow the safety alert symbol and either the word "DANGER" or "WARNING." These words mean:

! DANGER

You can be killed or seriously injured if you don't immediately follow instructions.

! WARNING

You can be killed or seriously injured if you don't follow instructions.

All safety messages will tell you what the potential hazard is, tell you how to reduce the chance of injury, and tell you what can happen if the instructions are not followed.

WARNING: For your safety, the information in this manual must be followed to minimize the risk of fire or explosion, or to prevent property damage, personal injury, or death.

- Do not store or use gasoline or other flammable vapors and liquids in the vicinity of this or any other appliance.
- **WHAT TO DO IF YOU SMELL GAS:**
 - Do not try to light any appliance.
 - Do not touch any electrical switch; do not use any phone in your building.
 - Clear the room, building, or area of all occupants.
 - Immediately call your gas supplier from a neighbor's phone. Follow the gas supplier's instructions.
 - If you cannot reach your gas supplier, call the fire department.
- Installation and service must be performed by a qualified installer, service agency, or the gas supplier.

IMPORTANT SAFETY INSTRUCTIONS

WARNING: To reduce the risk of fire, electric shock, or injury to persons when using the washer/dryer, follow basic precautions, including the following:

- Read all instructions before using the washer/dryer.
- Do not place items exposed to cooking oils in your dryer. Items contaminated with cooking oils may contribute to a chemical reaction that could cause a load to catch fire.
- Do not wash or dry articles that have been previously cleaned in, washed in, soaked in, or spotted with gasoline, dry-cleaning solvents, other flammable, or explosive substances as they give off vapors that could ignite or explode.
- Do not add gasoline, dry-cleaning solvents, or other flammable, or explosive substances to the wash water. These substances give off vapors that could ignite or explode.
- Do not allow children to play on or in the washer/dryer. Close supervision of children is necessary when the washer/dryer is used near children.
- Before the washer/dryer is removed from service or discarded, remove the doors to the washer/dryer compartments.
- Do not reach into the washer/dryer if the tub, agitator or drum is moving.
- Do not install or store the washer/dryer where it will be exposed to the weather.
- Do not tamper with controls.
- Clean dryer lint screen before or after each load.
- Under certain conditions, hydrogen gas may be produced in a hot water system that has not been used for 2 weeks or more. **HYDROGEN GAS IS EXPLOSIVE.** If the hot water system has not been used for such a period, before using the washing machine, turn on all hot water faucets and let the water flow from each for several minutes. This will release any accumulated hydrogen gas. As the gas is flammable, do not smoke or use an open flame during this time.
- Do not repair or replace any part of the washer/dryer or attempt any servicing unless specifically recommended in this Use and Care Guide or in published user-repair instructions that you understand and have the skills to carry out.
- Do not use fabric softeners or products to eliminate static unless recommended by the manufacturer of the fabric softener or product.
- Do not use heat to dry articles containing foam rubber or similarly textured rubber-like materials.
- Keep area around the exhaust opening and adjacent surrounding areas free from the accumulation of lint, dust, and dirt.
- The interior of the machine and dryer exhaust vent should be cleaned periodically by qualified service personnel.
- See "Electrical Requirements" for grounding instructions.

SAVE THESE INSTRUCTIONS

IMPORTANT: The gas installation must conform with local codes, or in the absence of local codes, with the National Fuel Gas Code, ANSI Z223.1/NFPA 54.

The dryer must be electrically grounded in accordance with local codes, or in the absence of local codes, with the National Electrical Code, ANSI/NFPA 70.

PARTS AND FEATURES

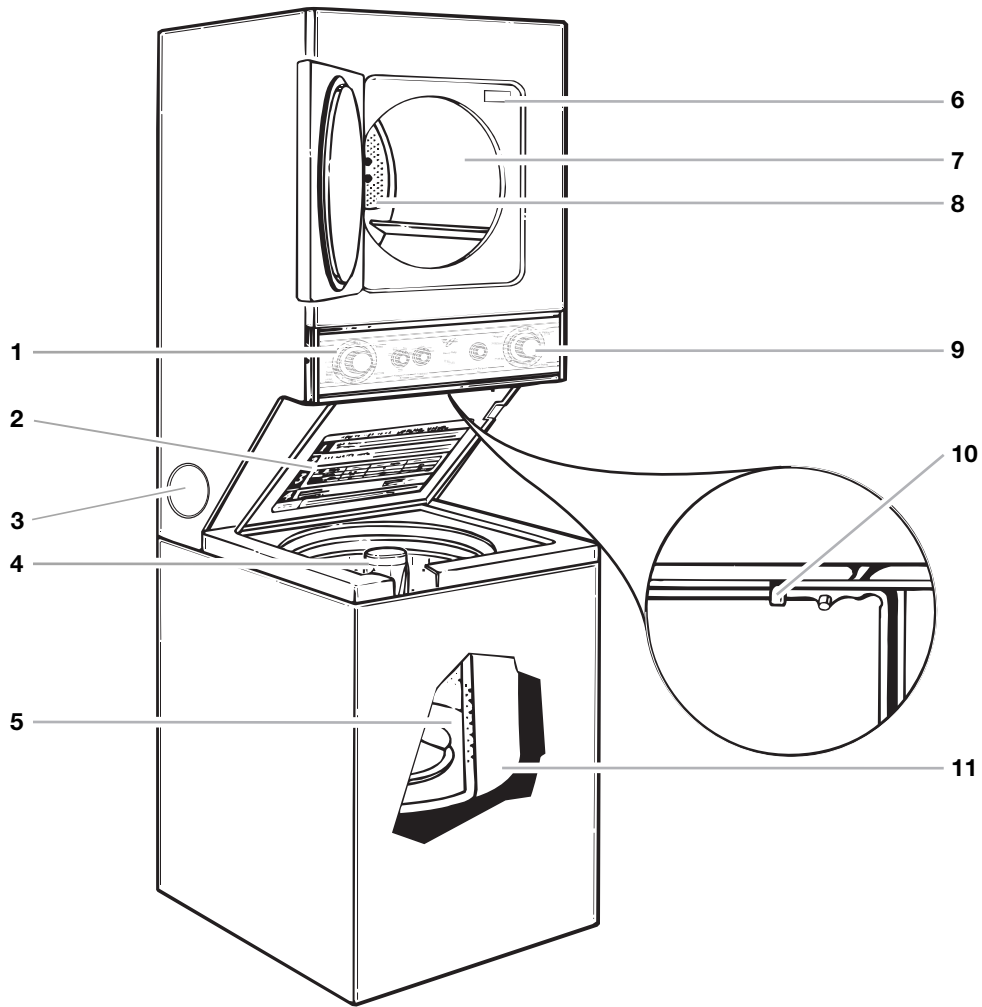

- 1. Washer controls
- 2. Lid instructions
- 3. Optional exhaust outlet
- 4. Agitator
- 5. Basket
- 6. Model and serial number plate
- 7. Dryer drum

- 8. Lint screen
- 9. Dryer Controls
- 10. Lid latch - Push to release
- 11. Tub

Other features:
 Temperature selector
 Load size selector

Control panel

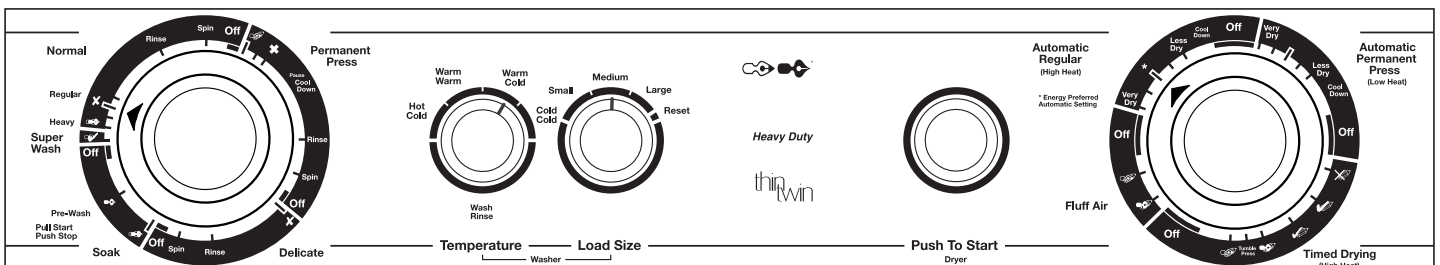

CHECKING YOUR VENT

Your dryer must be properly installed and vented to achieve maximum drying efficiency and shorten drying times. Use the minimum recommended installation clearances (found in your Installation Instructions) to avoid blocking the flow of combustion and ventilation air. Refer to your Installation Instructions for more information.

! WARNING



Fire Hazard

Use a heavy metal vent.

Do not use a plastic vent.

Do not use a metal foil vent.

Failure to follow these instructions can result in death or fire.

If the dryer is not properly installed and vented, it will not be covered under the warranty.

NOTE: Service calls caused by improper venting will be paid for by the customer, whether it was a paid installation or self-installed.

- Do not** use plastic vent or metal foil vent. Use 4 in. (10.2 cm) metal or flexible metal vent. Do not kink or crush flexible metal vent. It must be completely extended to allow adequate exhaust air to flow. Check vent after installation. Refer to your Installation Instructions for proper length requirements of vent.

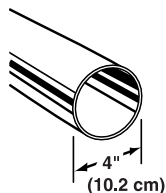

- Use a 4 in. (10.2 cm) exhaust hood. Smaller hoods increase drying times.

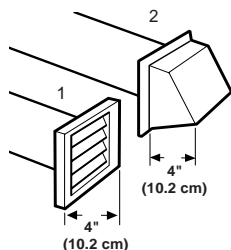

- The exhaust vent can be routed up, down, left, right, or straight out the back of the dryer. Space requirements are listed in your Installation Instructions.

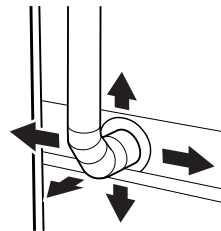

- Use the straightest path possible when routing the exhaust vent. Use the fewest number of elbows and turns. Allow room when using elbows or making turns. Bend vent gradually to avoid kinking.

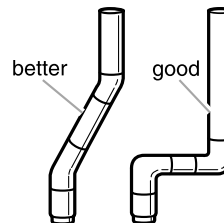

- Use duct tape to seal all joints. **Do not** use screws to secure vent. Lint may catch on screws.

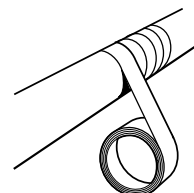

- Clean exhaust vent periodically, depending on use, but at least every 2 years, or when installing your dryer in a new location.

- Disconnect vent from the dryer and clean one section at a time until you reach the exhaust hood.

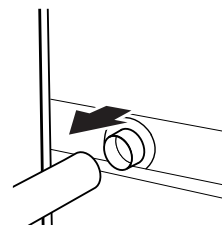

- To clean out lint, use the hose attachment on your vacuum, or a pole or wire with a feather duster or rag attached.
- Be sure the flapper on the outside end of vent moves freely.
- When cleaning is complete, be sure to follow the Installation Instructions supplied with your dryer for final product check.

WASHER USE

Understanding Washer Cycles





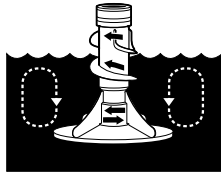



When the Cycle Control knob is set to a number and pulled out, the washer fills (to the selected load size) before agitation and timing start. The washer begins agitating immediately after filling; agitation occurs with the washer lid up or down.

During agitation, the agitator creates a continuous rollover action (on some models) that provides a thorough cleaning of the wash load.



After agitation starts, the Cycle Control knob turns clockwise until it points to an OFF area and the cycle ends.

NOTE: The washer pauses briefly throughout each cycle. These pauses are normal for washer operation.

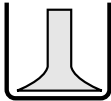
| WASH | RINSE |
|---|--|
|  1. Fill |  1. Fill |
|  2. Wash selected time |  2. Rinse |
|  3. Drain [†] No agitation |  3. Drain No agitation |
|  4. Spin |  4. Spin-Spray rinse |
| |  5. Spin |
| [†] The Permanent Press cycle partially drains, fills, agitates briefly, and drains. |  6. Off |

Loading

Loading suggestions

For these suggested full-sized loads, set the LOAD SIZE selector to the highest setting.

Compact Washers

Heavy Work Clothes

2 pants
3 shirts

Towels

9 bath towels
- or -
6 bath towels
3 hand towels
6 wash cloths

Mixed Load

1 pair slacks
2 pillowcases
2 shirts
1 T-shirt

Permanent Press

6 shirts
-or-
2 double sheets
2 pillow cases
-or-
2 single sheets
2 pillow cases

Delicates

1 camisole
2 slips
2 panties
2 bras
1 nightie
1 half slip

Knits

2 slacks
2 shirts
-or-
3 dresses

Normal Washer Sounds

Your new washer may make sounds your old one didn't. Because the sounds might be unfamiliar, you may be concerned about them. These sounds are normal.

During washing

When you select a small load size setting, your washer has a lower water level. This can cause a clicking sound from the upper part of the agitator.

During drain

If water is drained quickly from your washer (depending on your installation), you may hear air being pulled through the pump during the end of draining.

After drain and before spin

When the cycle changes from draining to spinning, you may hear gears engaging.

Starting Your Washer

⚠ WARNING



Fire Hazard

Never place items in the washer that are dampened with gasoline or other flammable fluids.

No washer can completely remove oil.

Do not dry anything that has ever had any type of oil on it (including cooking oils).

Doing so can result in death, explosion, or fire.

⚠ WARNING



Electrical Shock Hazard

Plug into a grounded 3 prong outlet.

Do not remove ground prong.

Do not use an adapter.

Do not use an extension cord.

Failure to follow these instructions can result in death, fire, or electrical shock.

1. Measure detergent and pour it into the washer. If desired, add powdered or liquid color safe bleach. Add extra detergent for the Extra Wash cycle.



Drop a sorted load of clothes loosely into your washer.

- Load evenly to maintain washer balance. Mix large and small items.
- Items should move easily through the wash water. Overloading can cause poor cleaning.
- To reduce wrinkling of permanent press clothes and some synthetic knits, use a large load size to provide more space (see step 3).

2. Close the washer lid.
3. Turn the WATER LEVEL selector to the correct setting for your wash load and the type of fabric being washed.

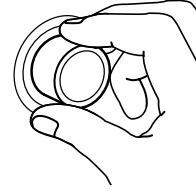

- Choose a load size that allows the load to move freely for best fabric care. See "Loading."
 - You may change the load size selection after the washer has started filling by turning the selector to Reset and then to the desired new setting.
4. Set the TEMPERATURE selector to the correct setting for the type of fabric and soils being washed. Use the warmest water safe for fabric. Follow garment label instructions.

| Water Temp | Use For |
|--|--|
| Hot 111°F (44°C) or above | Whites and pastels Heavy and greasy soils |
| Warm 90°-110°F (32°-43°C) | Bright colors Moderate to light soils |
| Cold 70°-90°F (21°-32°C) | Colors that bleed or fade Light soils |

NOTE: In wash water temperatures colder than 70°F (21°C), detergents do not dissolve well. Soils can be difficult to remove. Some fabrics can retain wear wrinkles and have increased pilling (the formation of small lint-like balls on the surface of garments).

5. Push in the Cycle Control knob and turn it clockwise to the wash cycle you want. Reduce the wash time when using a small load size setting. See "Selecting a Cycle and Time."

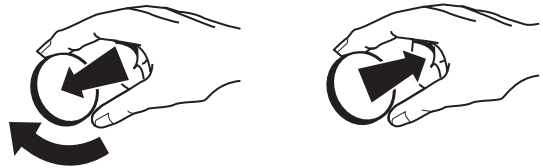

Pull out the Cycle Control knob to start the washer.

To stop or restart your washer

- To **stop** the washer at any time, push in the Cycle Control knob.
- To **restart** the washer, close the lid (if open) and pull out the Cycle Control knob.

Selecting a Cycle and Time

This section describes the available wash cycles and will help you make the best cycle selections for your wash loads. Each cycle is designed for different types of fabric and soil levels.

- The washer pauses briefly throughout each cycle. These pauses are normal. Refer to “Normal Washer Sounds” to learn more about the sounds you may hear during a wash cycle.
- Refer to “Understanding Washer Cycles” to learn what happens during a wash cycle.

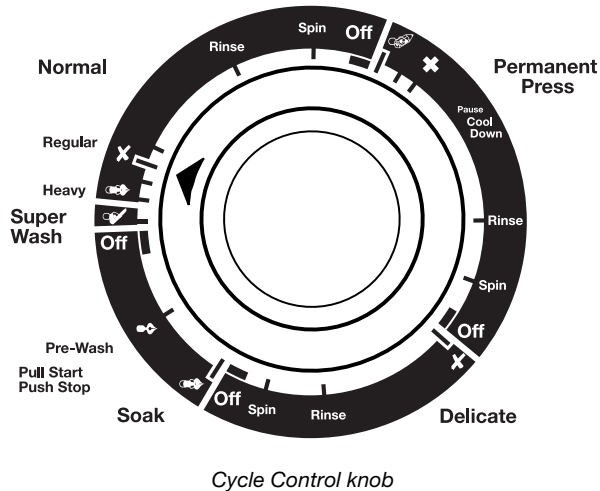

Normal cycle

The Normal cycle features the Gentle Wash system and high spin speeds to shorten drying time.

- Use Heavy, 12 minutes of wash time, to clean sturdily-constructed cotton and linen fabrics that are heavily soiled.
- Use Regular, 8 minutes of wash time, to clean cotton and linen fabrics that are lightly to moderately soiled.

Super Wash cycle

The Super Wash cycle automatically pre-washes the laundry and advances into the Normal wash cycle. The washer does not have to be reset after the Super Wash cycle. Use this 14-minute cycle when washing heavily soiled loads that need maximum soil removal.

- For proper cleaning, use double the amount of detergent recommended for the wash cycle.

Permanent Press cycle

The Permanent Press cycle features the Gentle Wash system, a cool-down rinse and low spin speeds to reduce wrinkling.

- Use 10 minutes of wash time to clean permanent press and some synthetic fabrics that are moderately soiled.
- Use 6 minutes of wash time to clean permanent press and some synthetics that are lightly soiled.

Delicate cycle

The Delicate cycle features a reduced agitation speed for gentle soil removal. Low spin speeds reduce wrinkling.

- Use 8 minutes of wash time to clean delicate items and washable knits that are lightly soiled.

Soak cycle

The Soak cycle features brief periods of agitation and soak time to help remove heavy soils and stains that need pretreatment.

- Use warm water when soaking. Hot water may set some stains.
- Use the amount of detergent or presoak additive recommended by manufacturer.
- The **2-minute Pre-Wash** time features high-speed agitation to help remove heavy soils and stains. Once the Pre-Wash period ends, add detergent and start a new cycle.

Rinse and Spin

When using extra detergent for heavily soiled clothes, or washing special-care items, you may find an extra rinse and spin is needed.

1. Push in the Cycle Control knob and turn it clockwise to any of the Rinse settings.
2. Pull out the Cycle Control knob. The washer fills to the selected load size, agitates, drains, and spins.

Drain and Spin

A drain and spin may help shorten drying times for some heavy fabrics or special-care items by removing excess water.

1. Push in the Cycle Control knob and turn it clockwise to any of the Spin settings.
2. Pull out the Cycle Control knob. The washer drains, then spins.

Adding Liquid Chlorine Bleach

Always measure liquid chlorine bleach. Do not guess. Never use more than 1 cup (250 mL) for a full load. Follow manufacturer's directions for safe use. Use a cup with a pouring spout to avoid spilling.

1. Let the washer fill and begin agitating the load.
2. Add bleach to the wash cycle so it can be removed in the rinse cycle. Pour bleach around the agitator, not directly on the load.
 - Follow directions on the care labels. Do not use chlorine bleach on wool, silk, spandex, acetates, or some flame-retardant fabrics.
 - When soaking with chlorine bleach, add detergent to soak water.

NOTE: Undiluted bleach will damage any fabric it touches. The damage appears as rips, holes, tears, or color loss and may not show up until several washings later.

Adding Liquid Fabric Softener

Always dilute fabric softener with ½ to 1 cup (125 to 250 mL) warm water. Undiluted fabric softener can stain fabrics.

- Add diluted fabric softener only in the final rinse.
- Fabric softener should not be mixed with other laundry products. Greasy stains can form. To remove greasy stains, wet the stain and rub with liquid detergent or a bar of soap. Rewash.
- Too much fabric softener can make some items (diapers and towels) nonabsorbent. If this happens, use less fabric softener, or do not use it every time.

DRYER USE

Starting Your Dryer

⚠ WARNING



Explosion Hazard

Keep flammable materials and vapors, such as gasoline, away from dryer.

Do not dry anything that has ever had anything flammable on it (even after washing).

Failure to follow these instructions can result in death, explosion, or fire.

⚠ WARNING



Fire Hazard

No washer can completely remove oil.

Do not dry anything that has ever had any type of oil on it (including cooking oils).

Items containing foam, rubber, or plastic must be dried on a clothesline or by using an Air Cycle.

Failure to follow these instructions can result in death or fire.

Before using your dryer, wipe the dryer drum with a damp cloth to remove dust from storing and shipping.

1. Load clothes loosely into the dryer and close the door. Do not pack the dryer. Allow space for clothes to tumble freely.

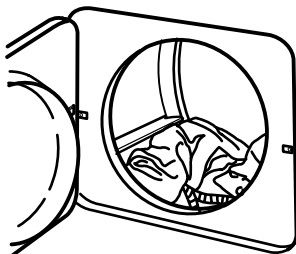

2. Turn the Cycle Control knob to the recommended cycle for the type of load being dried. Use the Energy Preferred Automatic Setting (*) to dry most heavyweight and medium weight loads. See "Drying, Cycle, and Temperature Tips."

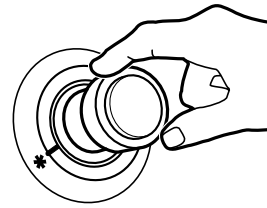

3. Select a temperature setting on models with a Temp/Fabric selector. The cycle descriptions include temperature setting suggestions.
4. Push the START button.

Stopping and Restarting

You can stop your dryer any time during a cycle.

To stop your dryer

Open the dryer door or turn the Cycle Control knob to OFF.

NOTE: The Cycle Control knob should point to an Off area when the dryer is not in use.

To restart your dryer

1. Close the door.
2. Select a new cycle and temperature (if desired).
3. Push START.

Loading

Load clothes loosely into the dryer. Do not pack the dryer. Allow space for clothes to tumble freely. The following chart shows examples of balanced loads that would allow proper tumbling.

COMPACT DRYER

Heavy Work Clothes

2 pants
3 shirts

Towels

9 bath towels
-or-
6 bath towels
3 hand towels
6 wash cloths

Mixed Load

1 pair slacks
2 pillowcases
2 shirts
1 T-shirt

Permanent Press

6 shirts
-or-
2 double sheets
2 pillow cases
-or-
2 single sheets
2 pillow cases

Delicates

1 camisole
2 slips
2 panties
2 bras
1 nightie
1 half slip

Knits

2 slacks
2 shirts
-or-
3 dresses

Drying, Cycle and Temperature Tips

Select the correct cycle and temperature for your load.

Cool Down tumbles the load without heat during the last few minutes of all cycles to make the load easier to handle.

Drying tips

- Follow care label directions when they are available.
- If you use fabric softener sheets, use only those labeled as dryer safe. Follow package instructions.
- Remove the load from the dryer as soon as tumbling stops, to reduce wrinkling. This is especially important for permanent press, knits, and synthetic fabrics.

Cycle and temperature tips

- Dry most loads using the Energy Preferred Automatic Setting (*).
- Use a High Heat setting for drying heavyweight items such as towels and work clothes.
- Use a Low Heat setting for drying lightweight items such as lingerie, blouses, dresses, and some knits.
- Use a no-heat (air) setting for rubber, plastic, or heat-sensitive fabrics.
- Line dry bonded or laminated fabrics.

If you are unsure of the temperature to select for a load, select a lower setting rather than a higher setting.

NOTE: If you have questions about drying temperatures for various loads, refer to the care label directions.

Your dryer has both a High Heat cycle (Regular and Timed Drying) and a Low Heat cycle (Permanent Press). Always follow care label directions when available, especially for delicate items.

NOTE: The Automatic cycles use an automatic dryness control that senses the exhaust temperature and determines the dryness of the load.

Timed Drying Cycle

Your dryer offers High Heat in the Timed Drying cycle. Use the Timed Drying cycle to complete drying if some items are damp after Automatic drying. Timed Drying is also useful for:

- Bulky items and large loads that require a long drying time.
- Damp drying items; turn the Cycle Control Knob to 30 minutes or less.

TUMBLE PRESS® Feature

The TUMBLE PRESS feature removes wrinkles from clothes that have been packed in a suitcase, or from items not removed from the dryer at the end of a cycle. Put only a few items in your dryer for best results when using this feature. As soon as the dryer stops, fold or put the items on hangers.

Fluff Air Cycle

Use the Fluff Air cycle for items that require drying without heat such as rubber, plastic and heat sensitive fabrics. This chart shows examples of items that can be dried using the Fluff Air cycle.

| Type of Load | Fluff Air* |
|--|------------|
| Foam rubber - pillows, padded bras, stuffed toys | 20 - 30 |
| Plastic - Shower curtains, tablecloths | 20 - 30 |
| Rubber-backed rugs | 40 - 50 |
| Olefin, polypropylene, sheer nylon | 10 - 20 |

(*Minutes) Reset cycle to complete drying, if needed.

When using Fluff Air

- Check to see that coverings are securely stitched.
- Shake and fluff pillows by hand periodically during cycle.
- Dry item completely. Foam rubber pillows are slow to dry.

Cycle Descriptions

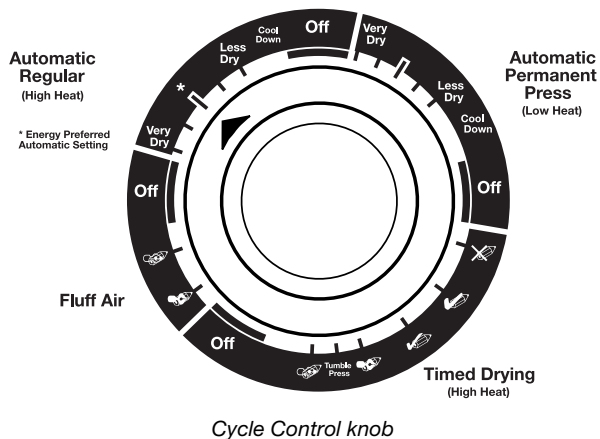

Automatic Cycle(s)

Dry most loads using the Energy Preferred Automatic Setting (*). Your Automatic cycle(s) shuts off when the selected dryness is reached. The Cycle Control Knob will not move until the load is almost dry. After the cool down, the knob automatically turns to an Off area and tumbling stops.

- If the load is drier than you like, select Less Dry the next time you dry a similar load.
- If the load is not as dry as you would like, complete drying using a Timed Drying cycle. Select Very Dry the next time you dry a similar load.

End of Cycle Signal

The dryer sounds a signal to let you know when the cycle is finished. The signal is helpful when you are drying permanent press, synthetics and other items that should be removed from the dryer as soon as it stops. The signal is not adjustable and cannot be turned off.

WASHER/DRYER CARE

Cleaning Your Washer

Cleaning the exterior

Use a soft, damp cloth or sponge to wipe up any spills such as detergent or bleach. Occasionally wipe the outside of your washer to keep it looking new.

Cleaning the interior

Clean your washer interior by mixing 1 cup (250 mL) of chlorine bleach and 2 scoops or caps full of detergent. Pour this into your washer and run it through a complete cycle using hot water. Repeat this process if necessary.

NOTE: Remove any hard water deposits using only cleaners labeled as washer safe.

Water Inlet Hoses

Replace inlet hoses after 5 years of use to reduce the risk of hose failure. Periodically inspect and replace inlet hoses if bulges, kinks, cuts, wear, or leaks are found.

When replacing your inlet hoses, mark the date of replacement on the label with a permanent marker.

Cleaning the Dryer Interior

⚠ WARNING



Explosion Hazard

Use nonflammable cleaner.

Failure to do so can result in death, explosion, or fire.

To clean dryer drum

1. Apply a liquid, non-flammable household cleaner to the stained area and rub with a soft cloth until all excess dye is removed.
2. Wipe drum thoroughly with a damp cloth.
3. Tumble a load of clean cloths or towels to dry drum.

NOTE: Garments which contain unstable dyes, such as denim blue jeans or brightly colored cotton items, may discolor the dryer interior. These stains are not harmful to your dryer and will not stain future loads of clothes. Dry unstable dye items inside out to prevent dye transfer.

Cleaning the Lint Screen

Every load cleaning

The lint screen is located in the dryer door opening. Remove lint before each load. A screen blocked by lint can increase drying time.

To clean

1. Pull out the lint screen and its cover.



2. Separate the cover and the screen by squeezing the screen and pulling on the cover at the same time.

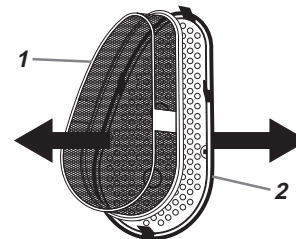

1. Screen
2. Cover

3. Roll lint off the screen with your fingers. Do not rinse or wash screen to remove lint. Wet lint is hard to remove.

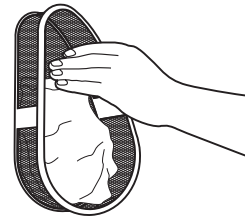

4. Put the lint screen and cover back together and push firmly back into place.

IMPORTANT:

- Do not run the dryer with the lint screen loose, damaged, blocked, or missing. Doing so can cause overheating and damage to both the dryer and fabrics.
- Some towels made of synthetic fibers and natural fibers (polyester and cotton blends) may shed more lint than other towels, causing your dryer's lint screen to fill up faster. Be sure to remove lint from the lint screen before and after drying new towels.
- If lint falls off the screen into the dryer during removal, check the exhaust hood and remove lint. See "Venting Requirements."

As needed cleaning

Laundry detergent and fabric softener residue can build up on the lint screen. This buildup can cause longer drying times for your clothes, or cause the dryer to stop before your load is completely dry. The screen is probably clogged if lint falls off the screen.

Clean the lint screen with a nylon brush every 6 months, or more frequently if it becomes clogged due to a residue buildup.

To wash

1. Roll lint off the screen with your fingers.
2. Wet both sides of lint screen with hot water.
3. Wet a nylon brush with hot water and liquid detergent. Scrub lint screen with the brush to remove residue buildup.

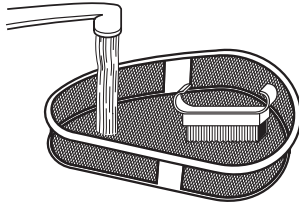

4. Rinse screen with hot water.
5. **Thoroughly** dry lint screen with a clean towel. Replace screen in dryer.

Removing Accumulated Lint

From inside the dryer cabinet

Lint should be removed every 2 years, or more often, depending on dryer usage. Cleaning should be done by a qualified person.

From the Exhaust Vent

Lint should be removed every 2 years, or more often, depending on dryer usage.

Vacation, Storage, and Moving Care

Install and store your washer/dryer where it will not freeze. Because some water may stay in the hoses, freezing can damage your washer/dryer. If storing or moving your washer/dryer during freezing weather, winterize it.

Non-use or vacation care

Operate your washer/dryer only when you are at home. If you will be on vacation or not using your washer/dryer for an extended period of time, you should:

- Unplug washer/dryer or disconnect power.
- Turn off the water supply to the washer. This helps avoid accidental flooding (due to a water pressure surge) while you are away.

To winterize washer/dryer

1. Shut off both water faucets.
2. Disconnect and drain water inlet hoses.
3. Put 1 quart (1 L) of R.V.-type antifreeze in the basket.
4. Run washer on a drain and spin setting for about 30 seconds to mix the antifreeze and water.
5. Unplug washer/dryer or disconnect power.

To use washer/dryer again

1. Flush water pipes and hoses.
2. Reconnect water inlet hoses.
3. Turn on both water faucets.
4. Plug in washer/dryer or reconnect power.
5. Run the washer through a complete cycle with 1 cup (250 mL) of detergent to clean out antifreeze.

To transport the washer/dryer

1. Shut off both water faucets.
2. Disconnect and drain water inlet hoses.
3. If washer/dryer will be moved during freezing weather, put in a quart (1 L) of R.V.-type antifreeze in the basket. Run washer on a spin setting for about 30 seconds to mix the antifreeze and water.
4. Disconnect the drain from the drain system.
5. Unplug washer/dryer or disconnect power.
6. Disconnect the exhaust vent.
7. If your washer/dryer is a gas model, close shut-off valve in gas supply line.
8. If your washer/dryer is a gas model, disconnect gas supply line pipe and remove fittings attached to the washer/dryer pipe.
9. Wash lint screen.
10. Make sure leveling legs are secure.
11. Place the inlet hoses into the basket.
12. Drape the power cord and drain hose over edge and into the basket.
13. Use masking tape to secure the washer lid and dryer door.

Re-installing your washer/dryer

1. Follow the "Installation Instructions" to locate, level, and connect the washer/dryer.
2. Run the washer through the Normal cycle with 1 scoop or cap full of detergent to clean the washer and remove the antifreeze, if used.

TROUBLESHOOTING WASHER

First try the solutions suggested here and possibly avoid the cost of a service call...

Washer won't fill, rinse or agitate

- **Check the following:**
 - Is the power cord plugged into a grounded outlet?
 - Is the indicator on the Cycle Control knob properly lined up with a cycle? Turn the Cycle Control knob to the right slightly and pull to start.
 - Are the water inlet valve screens clogged?
 - Are both the hot and cold water faucets turned on?
 - Is the water inlet hose kinked?
- **Does the water level seem too low, or does the washer appear to not fill completely?**

The top of the agitator is much higher than the highest water level. This creates a perception that the washer is not filling completely. This is normal.

Washer stops

- **Check the following:**
 - Is the power cord plugged into a grounded outlet?
 - Is the indicator on the Cycle Control knob properly lined up with a cycle? Turn the Cycle Control knob to the right slightly and pull to start.
 - Are the water inlet valve screens clogged?
 - Are both the hot and cold water faucets turned on?
 - Is the water inlet hose kinked?
- **Is there power at the plug?**

Check your electrical source or call an electrician.
- **Has a fuse blown or is the circuit breaker open?**

If problem continues, call an electrician.
- **Are you using an extension cord?**

Do not use an extension cord.
- **Is the washer overloaded?**

Wash smaller loads.
- **Is the washer in a normal pause in the Permanent Press cycle?**

The washer pauses for about 2 minutes in the Permanent Press cycle. Allow the cycle to continue.

Washer won't drain or spin

- **Is the drain hose clogged, or the end of the drain hose more than 96 in. (2.4 m) above the floor?**

See the Installation Instructions for proper installation of drain hose.
- **Is the lid open?**

The lid must be closed during operation.
- **Is there excessive sudsing?**

Always measure detergent. Follow manufacturer's directions. If you have very soft water, you might need to use less detergent.
- **Is your voltage low?**

Check your electrical source or call an electrician. Do not use an extension cord.

Washer continues to fill or drain, or the cycle seems stuck

- **Is the top of drain hose lower than the water level in washer?**

The top of the hose must be higher than the water level in the washer for proper operation (see "Installation Instructions").
- **Does the drain hose fit too tightly in the standpipe, or is it taped to the standpipe?**

The drain hose should be loose yet fit securely. Do not seal the drain hose with tape. The hose needs an air gap. (See "Installation Instructions.")

Washer makes noise

- **Is the load balanced and the washer/dryer level?**

The wash load should be balanced and not overloaded.

The washer/dryer must be level. The front feet should be properly installed and the nuts tightened. Reset the rear leveling legs (if needed). See "Installation Instructions."
- **Gears are engaging after the drain and before spin.**

These are normal washer noises.

Washer leaks

- **Check the following:**

Are the fill hoses tight? Are the fill hose washers properly seated? Is the drain hose clamp properly installed? (See "Installation Instructions.")
- **Is the sink or drain clogged?**

Sink and standpipe must be able to handle 17 gallons (64 L) of water per minute.
- **Is water deflecting off the tub ring or the load?**

Center the tub before starting the washer.

The wash load should be balanced and not overloaded. The fill or spray rinses can deflect off the load.

The washer/dryer must be level. Ensure leveling legs are installed (see "Installation Instructions").
- **Check household plumbing for leaks.**

Washer basket is crooked

- **Was the washer basket pulled forward during loading?**
The wash load should be balanced and not overloaded. Push the basket to the center before starting wash.
- **Is the load balanced and the washer/dryer level?**
The wash load should be balanced and not overloaded.
The washer/dryer must be level. Ensure leveling legs are installed (see “Installation Instructions”).
- **The washer basket moves while washing.**
This is normal.

Agitator operation

- **The top of the agitator is loose, or moves in only one direction.**
This is normal.

Load too wet

- **Did you use the right cycle for the load being washed?**
Select a cycle with a higher spin speed (if available).
- **Did you use a cold rinse?**
Cold rinses leave loads wetter than warm rinses. This is normal.

Residue or lint on load

- **Did you sort properly?**
Sort lint givers (towels, chenille) from lint takers (corduroy, synthetics). Also sort by color.
- **Did you overload the washer?**
The wash load must be balanced and not overloaded. Lint can be trapped in the load if overloaded. Wash smaller loads.
- **Check the following:**
Was paper or tissue left in the pockets?
Did you use enough detergent? Follow manufacturer’s directions. Use enough detergent to hold the lint in the water.
Is your water colder than 70°F (21°C)? Wash water colder than 70°F (21°C) may not completely dissolve the detergent.

Stains on load

- **Did you follow the manufacturer’s directions when adding detergent and fabric softener?**
Measure detergent and fabric softener. Use enough detergent to remove soil and hold it in suspension.
Dilute fabric softener and add to the rinse portion of a cycle only. Do not drip fabric softener on clothes.
- **Is there above average iron (rust) in water?**
You may need to install an iron filter.
- **Did you properly sort the load?**
Sort dark clothes from whites and lights.
- **Did you unload the washer promptly?**
To avoid dye transfer, unload the washer as soon as it stops.

Load is wrinkled

- **Did you use the right cycle for the load being washed?**
Use a cycle with a low spin speed to reduce wrinkling.
- **Did you unload the washer promptly?**
Unload the washer as soon as it stops.
- **Did you overload the washer?**
The wash load must be balanced and not overloaded. Loads should move freely during washing.
- **Was the wash water warm enough to relax wrinkles?**
If safe for the load, use warm wash water.
- **Are the hot and cold water hoses reversed?**
Check to be sure the hot and cold water hoses are connected to the right faucets (see “Installation Instructions”).

Load is tangled or twisted

- **Did you overload the washer?**
The wash load must be balanced and not overloaded. Loads should move freely during washing (see “Loading”).
- **Did you wrap items around the agitator?**
Drop items loosely into the washer. Do not wrap items around the agitator.

Gray whites, dingy colors

- **Did you properly sort the load?**
Dye transfer can occur when mixing whites and colors in a load. Sort dark clothes from whites and lights.
- **Was the wash temperature too low?**
Use warm washes if safe for the load.
- **Did you use enough detergent, or do you have hard water?**
Use more detergent for washing heavy soils in cold or hard water.
- **Are the hot and cold water hoses reversed?**
Check to be sure the hot and cold water hoses are connected to the right faucets (see “Installation Instructions”).

Garment damage

- **Check the following:**
Were sharp items removed from pockets before washing?
Empty pockets, zip zippers, snap or hook fasteners before washing.
Were strings and sashes tied to prevent tangling?
Were items damaged before washing? Mend rips and broken threads in seams before washing.
- **Did you overload the washer?**
The wash load must be balanced and not overloaded. Loads should move freely during washing.
- **Did you properly add chlorine bleach?**
Do not pour chlorine bleach directly on load. Wipe up bleach spills. Undiluted bleach will damage fabrics.
- **Did you follow the manufacturer’s care label instructions?**

TROUBLESHOOTING DRYER

First try the solutions suggested here and possibly avoid the cost of a service call...

Clothes are not drying satisfactorily

- **Check the following:**
Is the lint screen clogged with lint?

Is the exhaust vent or outside exhaust hood clogged with lint, restricting air movement? Run the dryer for 5-10 minutes. Hold your hand under the outside exhaust hood to check air movement. If you do not feel air movement, clean exhaust system of lint or replace exhaust vent with heavy metal or flexible metal vent (see "Installation Instructions").

Is the exhaust vent crushed or kinked? Replace with heavy metal or flexible metal vent. See your Installation Instructions.

Has a fuse blown, or a circuit breaker tripped? Electric dryers use 2 household fuses or breakers. The drum may be turning but you may not have heat.

Has an air cycle been selected? Select the right cycle for the types of garments being dried (see "Drying, Cycle and Temperature Tips").

For gas dryers, is the valve open on the supply line?

Are fabric softener sheets blocking the grille? Use only one fabric softener sheet and only use it once.
- **Is the dryer located in a room with temperature below 45°F (7°C)?**
Proper operation of dryer cycles requires temperatures above 45°F (7°C).
- **Was a cold rinse water used? Was the load very wet?**
Expect longer drying times with items rinsed in cold water and with items that hold moisture (cottons).
- **Is the load too large and heavy to dry quickly?**
Separate the load to tumble freely.

Dryer will not run

- **Check the following:**
Is the power cord plugged in?

Has a fuse blown, or has a circuit breaker tripped?

Was a regular fuse used? Use a time-delay fuse.

Is the dryer door firmly closed?

Was the START button firmly pressed?

Is a cycle selected?

Unusual sounds

- **Has the dryer had a period of non-use?**
If the dryer hasn't been used for a while, there may be a thumping sound during the first few minutes of operation.
- **Is it a gas dryer?**
The gas valve clicking is a normal operating sound.

Lint on load

- **Is the lint screen clogged?**
Clean lint screen. Check for air movement.
- **Is the load properly sorted?**
Sort lint givers (towels, chenille) from lint takers (corduroy, synthetics). Also sort by color.
- **Is the load too big or too heavy?**
Dry smaller loads so lint can be carried to the lint screen.
- **Was the load overdried?**
Use correct dryer settings for load type. Overdrying can cause lint-attracting static electricity (see "Drying, Cycle, and Temperature Tips").
- **Was paper or tissue left in pockets?**
- **Is pilling being mistaken for lint?**
Pilling (surface fuzz) is caused by normal wear and laundering.

Stains on load or color change

- **Was dryer fabric softener properly used?**
Add dryer fabric softener sheets at the beginning of the cycle. Fabric softener sheets added to a partially-dried load can stain your garments.
- **Were items soiled when placed in the dryer?**
Items should be clean before being dried.
- **Were items properly sorted?**
Sort light colors from dark colors. Sort colorfast items from non-colorfast items.

Items shrinking

- **Was the dryer overloaded?**
Dry smaller loads that can tumble freely.
- **Did the load overdry?**
Check the manufacturer's care label. Match dryer setting to load type (see "Drying, Cycle, and Temperature Tips").

Loads are wrinkled

- **Was the load removed from dryer at the end of the cycle?**
- **Was the dryer overloaded?**
Dry smaller loads that can tumble freely.
- **Did the load overdry?**
Check the manufacturer's care label. Match dryer setting to load type (see "Drying, Cycle, and Temperature Tips").

Odors

- **Have you recently been painting, staining or varnishing in the area where your washer/dryer is located?**
If so, ventilate the area. When the odors or fumes are gone from the area, re-wash and dry the clothing.
- **If the dryer is electric, is it being used for the first time?**
The new electric heating element may have an odor. The odor will be gone after the first cycle.

Garment damage

- **Check the following:**
 - Were zippers, snaps, and hooks left open?
 - Were strings and sashes tied to prevent tangling?
 - Were care label instructions followed?
 - Were items damaged before drying?

ASSISTANCE OR SERVICE

Before calling for assistance or service, please check "Troubleshooting." It may save you the cost of a service call. If you still need help, follow the instructions below.

When calling, please know the purchase date and the complete model and serial number of your appliance. This information will help us to better respond to your request.

If you need replacement parts

If you need to order replacement parts, we recommend that you only use FSP® factory specified parts. These parts will fit right and work right because they are made with the same precision used to build every new WHIRLPOOL® appliance.

To locate FSP® replacement parts in your area:

In the U.S.A., call the Customer Interaction Center at **1-800-253-1301**, or your nearest designated service center.

Our consultants provide assistance with:

- Features and specifications on our full line of appliances
- Installation information
- Use and maintenance procedures
- Accessory and repair parts sales
- Specialized customer assistance (Spanish speaking, hearing impaired, limited vision, etc.)
- Referrals to local dealers, repair parts distributors, and service companies

Whirlpool designated service technicians are trained to fulfill the product warranty and provide after-warranty service anywhere in the United States.

To locate the Whirlpool designated service company in your area, you can also look in your telephone directory Yellow Pages.

For further assistance

If you need further assistance, you can write to Whirlpool Corporation with any questions or concerns at:

Whirlpool Brand Home Appliances
Customer Interaction Center
553 Benson Road
Benton Harbor, MI 49022-2692

Please include a daytime phone number in your correspondence.

Gearcase assembly covered by your warranty

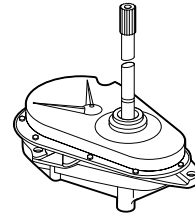

WHIRLPOOL® WASHER/DRYER WARRANTY

ONE-YEAR FULL WARRANTY

For one year from the date of purchase, when this washer/dryer is operated and maintained according to instructions attached to or furnished with the product, Whirlpool Corporation will pay for FSP® replacement parts and repair labor to correct defects in materials or workmanship. Service must be provided by a Whirlpool designated service company.

SECOND THROUGH FIFTH-YEAR LIMITED WARRANTY - ON TOP, LID AND GEARCASE ASSEMBLY

For second through fifth year from the date of purchase, when this washer/dryer is operated and maintained according to instructions attached to or furnished with the product, Whirlpool Corporation will pay for FSP® replacement parts for the following components, if defective in materials or workmanship: top and lid (if rusted); any part of the gearcase assembly.

SECOND THROUGH TENTH-YEAR LIMITED WARRANTY - ON OUTER TUB

For second through tenth year from the date of purchase, when this washer/dryer is operated and maintained according to instructions attached to or furnished with the product, Whirlpool Corporation will pay for FSP® replacement parts for the outer tub should it crack or fail to contain water, if defective in materials or workmanship.

Whirlpool Corporation will not pay for:

1. Service calls to correct the installation of your washer/dryer, to instruct you how to use your washer/dryer, or to replace house fuses, reset circuit breakers, correct house wiring, plumbing or venting or to replace owner accessible light bulbs. Heavy 4 in. (10.2 cm) metal exhaust vent must be used. Refer to the venting section of this manual and your Installation Instructions.
 2. Repairs when your washer/dryer is used in other than normal, single-family household use.
 3. Damage resulting from accident, alteration, misuse, abuse, fire, flood, acts of God, improper installation (including, but not limited to, venting with plastic or flexible foil), installation not in accordance with local electrical and plumbing codes, or use of products not approved by Whirlpool Corporation.
 4. Any labor costs incurred during the limited warranty periods.
 5. Replacement parts or repair labor costs for units operated outside the United States.
 6. Pickup and delivery. This product is designed to be repaired in the home.
 7. Repairs to parts or systems resulting from unauthorized modifications made to the appliance.
-

WHIRLPOOL CORPORATION SHALL NOT BE LIABLE FOR INCIDENTAL OR CONSEQUENTIAL DAMAGES.

Some states do not allow the exclusion or limitation of incidental or consequential damages, so this exclusion or limitation may not apply to you. This warranty gives you specific legal rights and you may also have other rights which vary from state to state.

Outside the 50 United States, this warranty does not apply. Contact your authorized Whirlpool dealer to determine if another warranty applies.

If you need service, first see "Troubleshooting." Additional help can be found by checking "Assistance or Service," or by calling our Customer Interaction Center at **1-800-253-1301**, from anywhere in the U.S.A., or write: Whirlpool Corporation, Customer Interaction Center, 553 Benson Road, Benton Harbor, MI 49022-2692.

4/00

Keep this book and your sales slip together for future reference. You must provide proof of purchase or installation date for in-warranty service.

Write down the following information about your washer/dryer to better help you obtain assistance or service if you ever need it. You will need to know your complete model number and serial number. You can find this information on the model and serial number label/plate, located on your appliance as shown in "Parts and Features."

Dealer name _____

Address _____

Phone number _____

Model number _____

Serial number _____

Purchase date _____

3406877

© 2001 Whirlpool Corporation.
All rights reserved.

© Registered Trademark/TM Trademark of Whirlpool, U.S.A.,
Whirlpool Canada Licensee in Canada

7/01
Printed in U.S.A.